

Features

- Includes two 42" x 96" walls, one 60" x 96" wall, and two 96" corner joints
- No need to install trim. Factory-installed edge provides a finished look for walls
- Joint system hides caulk and silicone, leaving fewer places for mold to grow and simplifying cleaning
- Coordinates with Choreograph shower accessories and storage (sold separately)
- Matte finish complements any decor

Material

- Serica™, KOHLER's proprietary composite material, offers unparalleled durability, strength, and aesthetic beauty
- VeinCut and CrossCut colors are based on the unique and intricate patterns of real stone; variation in the pattern is normal
- Choreograph walls made from Serica are repairable. KOHLER's ASR network can assist in repairing surface defects, cracks, etc. Customer service can assist in scheduling a repair. Repair kit part numbers: Patterned panels: 1374534-NY, 1374534-G9, 1374534-96. Solid Panels: 1283194 - *

Installation

- Field trimmable
- Adheres to water-resistant wallboard
- For a 60" x 42" x 96" three-wall alcove or smaller
- Intended for following use – residential (single family & multifamily) and hotel guest rooms

Included Components

Product consists of:

97604
97602
97602
97635

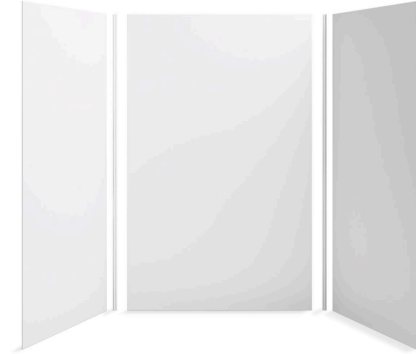

Codes/Standards







ASTM E162
ASTM E662

KOHLER® Choreograph Shower Walls and Accessories Limited Warranty

See website for detailed warranty information.

Available Colors/Finishes

Color tiles intended for reference only.

Color	Code	Description
	0	White
	96	Biscuit
	NY	Dune
	W07	VeinCut in Dune
	W08	VeinCut in Biscuit
	W10	Crosscut in Dune
	W11	Crosscut in Biscuit

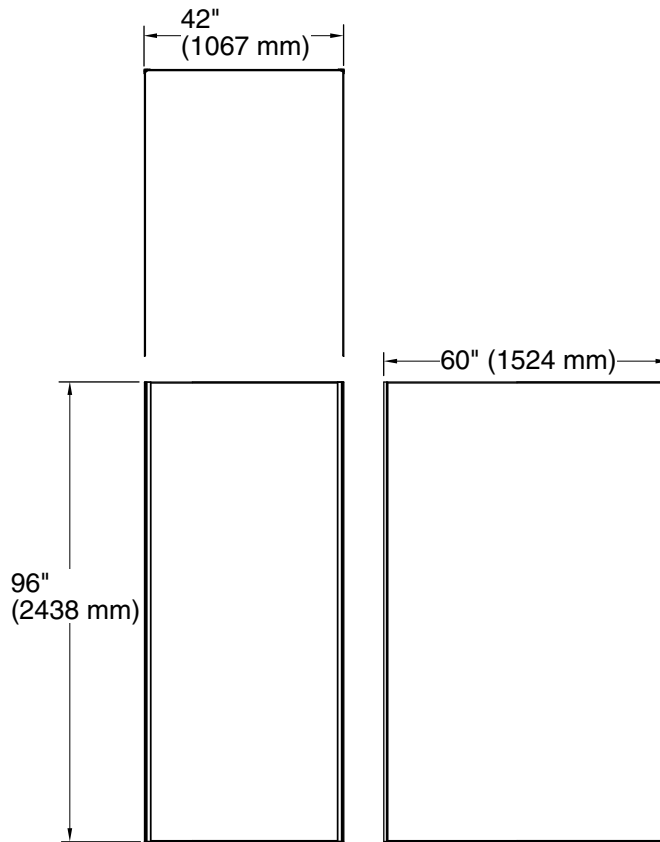

Technical Information

All product dimensions are nominal.

Installation: Three-wall alcove

Notes

Measure your actual product for rough-in details.

Install this product according to the installation instructions.

Use non-solvent based construction adhesive. For installation over tile, use 100% silicone sealant.

Corner joints (optional) allow for 3/8" (10 mm) adjustment for out-of-plumb conditions or uneven cuts.

If installing accessories, install 2x4 backing for handrails, shelves, and shower hooks and 2x10 backing for the flip down seat.